

**Modular Series**

**Features:**

- UL94V-0 polycarbonate body
- True knife blade, insulating piercing contacts
- Compatible with standard crimping tools
- Compatible with all FCC specifications
- Flat cable Plug available on request
- 50µ" gold plated contacts as standard. Other platings on request. (6, 15 & 30µ")

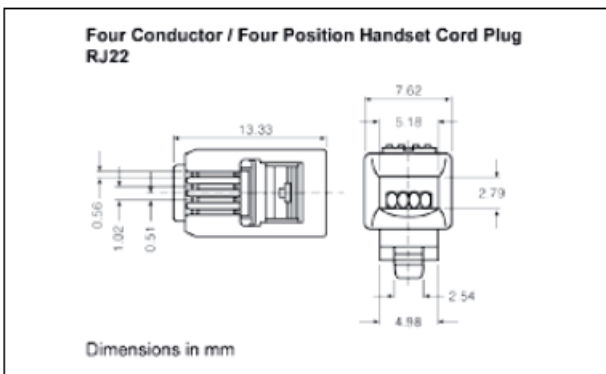
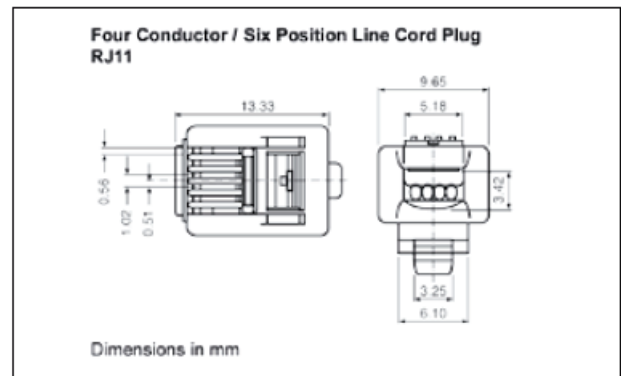
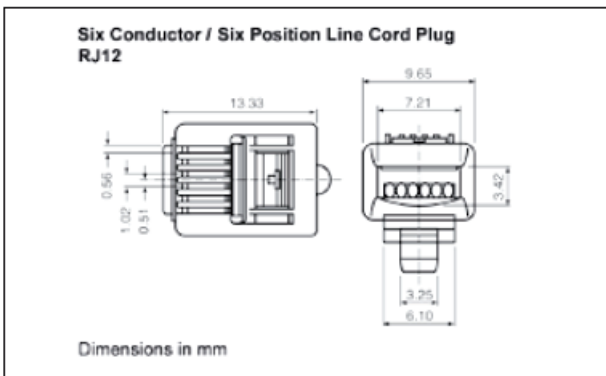
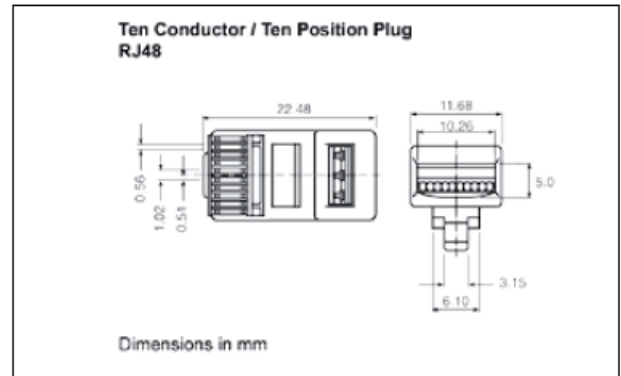
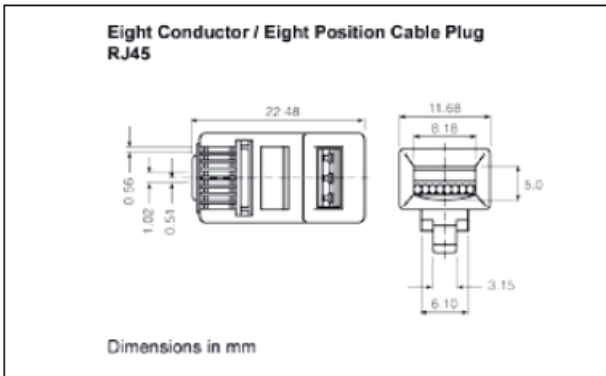
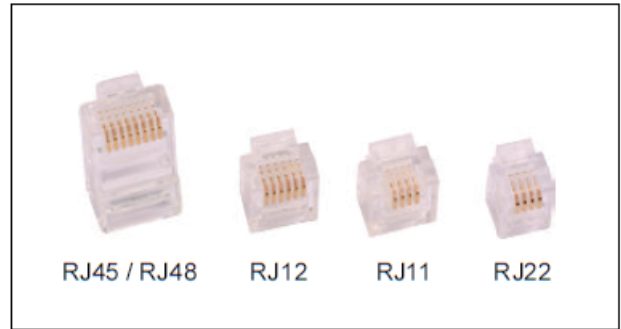

**Ordering information:**

Size:	P/N - BULK:	Product Code:
8P8C	6510-0104-01	RJ45-8P8CR
4P4C	6510-0104-02	RJ22-4P4CR
6P4C	6510-0104-03	RJ11-6P4CR
6P6C	6510-0104-04	RJ12-6P6CR
10P10C	6510-0104-05	RJ48-10P10CR

## Modular Series

### RJ45SRB - Series



#### Features:

- Standard version OD up to 6.0 mm
- Small version OD up to 4.3 mm
- Available in 11 standard colours
- Custom colours available upon request

#### Ordering information:

Standard 6.0 mm

Colour:	P/N - BULK:	Product Code:
Light Grey	6510-0100-01	RJ45SRB-LG
Dark Grey	6510-0100-02	RJ45SRB-DG
Blue	6510-0100-03	RJ45SRB-B
Yellow	6510-0100-04	RJ45SRB-Y
Green	6510-0100-05	RJ45SRB-G
Black	6510-0100-06	RJ45SRB-BK
Purple	6510-0100-07	RJ45SRB-P
White	6510-0100-08	RJ45SRB-W
Orange	6510-0100-09	RJ45SRB-O
Red	6510-0100-10	RJ45SRB-R
Pink	6510-0100-11	RJ45SRB-PK

For Small version, 4.3 mm: 6510-0101-xx / RJ45SRB-SM-xx

### RJ45SRB - Translucent Series

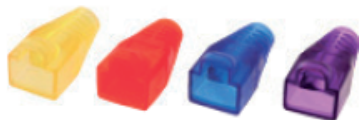

#### Features:

- Standard version OD up to 6.0 mm
- Available in 6 standard colours
- Custom colours available upon request

#### Ordering information:

Standard 6.0 mm

Colour:	P/N - BULK:	Product Code:
Blue	6510-0100-21	RJ45SRB-TRANS-B
Yellow	6510-0100-22	RJ45SRB-TRANS-Y
Green	6510-0100-23	RJ45SRB-TRANS-G
Purple	6510-0100-24	RJ45SRB-TRANS-P
Orange	6510-0100-25	RJ45SRB-TRANS-O
Red	6510-0100-26	RJ45SRB-TRANS-R

### RJ45SRB - Retrofit Series



#### Features:

- Retrofit style for provision of strain relief / Colour Coding after Cable Assembly has been made. (On Site Coding)

#### Ordering information:

Colour:	P/N - BULK:	Product Code:
Light Grey	6510-0102-01	RJ45SRB-RET-LG
Dark Grey	6510-0102-02	RJ45SRB-RET-DG
Blue	6510-0102-03	RJ45SRB-RET-B
Yellow	6510-0102-04	RJ45SRB-RET-Y
Green	6510-0102-05	RJ45SRB-RET-G
Black	6510-0102-06	RJ45SRB-RET-BK
Purple	6510-0102-07	RJ45SRB-RET-P
White	6510-0102-08	RJ45SRB-RET-W
Orange	6510-0102-09	RJ45SRB-RET-O
Red	6510-0102-10	RJ45SRB-RET-R

### RJ45 Couplers



#### Features:

- Available in Shielded or Unshielded
- Compatible with Industry standard Panel Cut outs

#### Ordering information:

Type / Size:	P/N - BULK:	Product Code:
Unshielded Cat5e	2101-0115-01	3101-8821
Shielded Cat5e	2101-0115-02	3101S-8821

Werner Wirth GmbH

Hellgrundweg 111  
22525 Hamburg  
Germany

Tel +49 (0)40 752 491-0  
Fax +49 (0)40 752 491-91

info@wernerwirth.de  
www.wernerwirth.de



**WERNER  
WIRTH**

PROJECT | CONNECT | PROTECT